

Solar Heating System Factsheet

SE 300/2



System model SE 300/2
System type Thermosiphon system
Manufacturer Solartech
 Sales & Service Sdn. Bhd.
Address 5, Jalan Teknologi 3/5,
 Kota Damansara
 47810 Petaling Jaya, Selangor
Phone +603 6157 4888
Fax +603 6156 8988
E-mail info@solartech.com.my
Internet www.solartech.com.my
Date of test 08.2012

- Performance test EN12976:2006
- Quality test EN12976:2006

- Solar Keymark



System-Data

No. of collector modules/pipes 2
Gross collector area 3.954 m²
Storage tank volume 300 l
Design load^{*)} 210 l/d

Types of collector mounting

- Construction for sloping roof
- Integration into sloping roof
- On flat roof with stand
- Facade

Gross dimensions flat roof (D x W x H)

2250 mm x 2630 mm x 1520 mm

Gross dimensions sloping roof (L x W)

n/a

Collector

Model SUMMER TX
Type Flat-plate collector
Total length 1938 mm

Total width 1020 mm
Gross area 1.977 m²
Weight empty 32 kg

Storage tank

Model CE 300
Type Horizontal
Insulation material Polyurethane foam
Corrosion protection Enamelled,
 Mg sacrificial anode
Total length 2290 mm

Outside diameter 510 mm
Weight empty 83 kg
Electrical heater 3 kW
Max. operating pressure 8.5 bar
Max. storage temperature 99 °C

Heat transfer medium solar loop

Manufacturer --
Type Direct system, no heat transfer medium

Model --
Concentration/Freezing point -- / --

Schematic of system

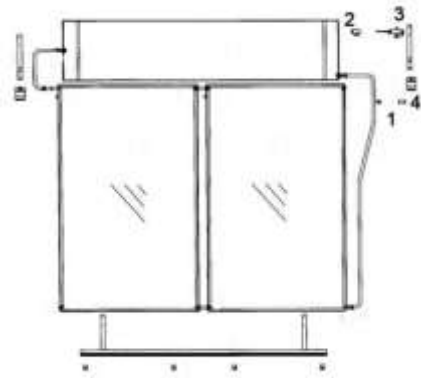

- 1 Cold water inlet
- 2 Hot water outlet
- 3 Temperature and pressure relief valve (99 °C / 8.5 bar)
- 4 Non-return valve

Annual performance prediction and solar fraction for the EN locations*

Davos

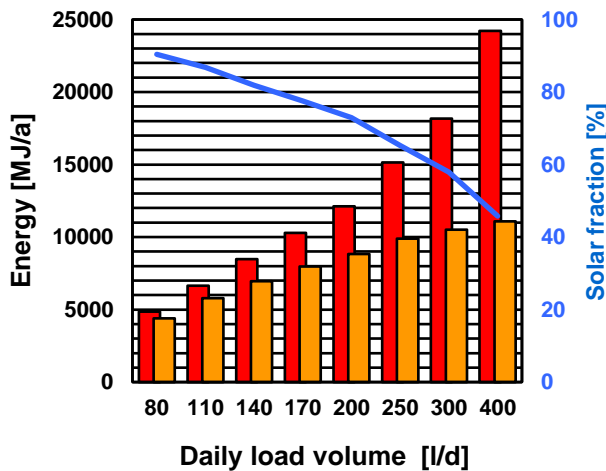

Stockholm

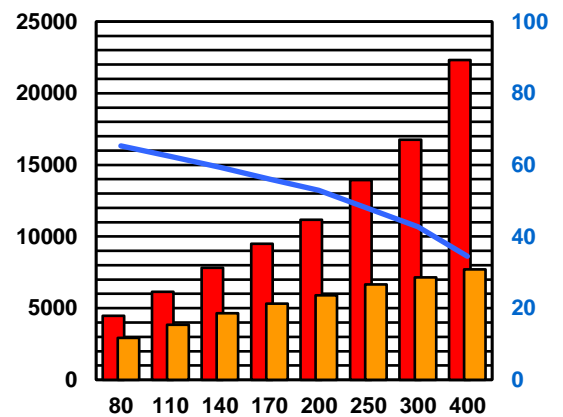

Würzburg

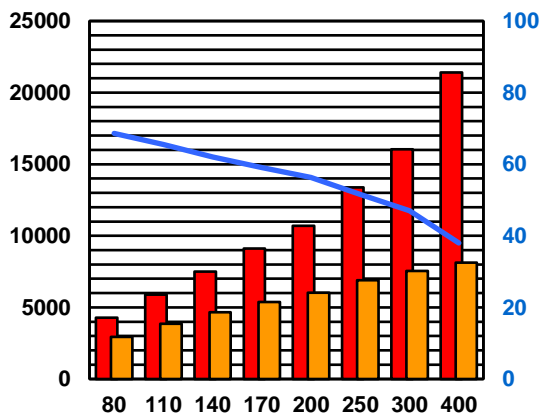

Athens

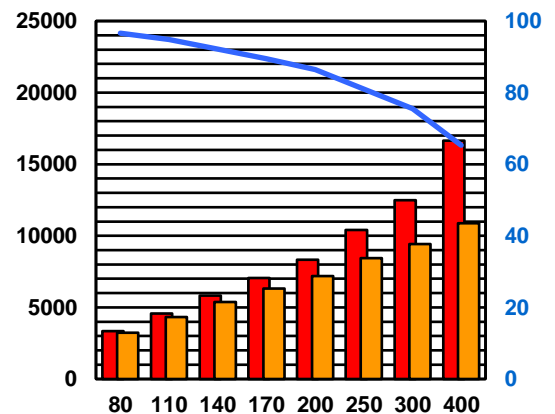

Reference conditions according to EN 12976

- Collector alignment South, tilt angle 45°
- Hot water temperature 45°C
- Draw-off 6 h after solar noon; 100 %

Performance indicators

- f_{sol} : Solar fraction in % ($f_{sol} = Q_L/Q_d$)
- Q_L : Heat delivered by the solar system (load)
- Q_d : Heat demand

¹⁾ The reference conditions for annual performance prediction in accordance with EN 12976:2006 are described in the **accompanying document to the system factsheets.**

Solar Heating System Factsheet

SE 180/1 – sub system

This system configuration was tested as part of a system family according to the CEN Keymark Scheme Rules for Solar Thermal Products¹. The annual performance prediction for the system configuration has been determined using the results of the medium system of the system family. For more information about the medium system please check the factsheet of system **S183**.



General

System model	SE 180/1	Phone	+603 6157 4888
System type	Thermosiphon system	Fax	+603 6156 8988
Manufacturer	Solartech Sales & Service Sdn. Bhd.	E-Mail	info@solartech.com.my
Address	5, Jalan Teknologi 3/5, Kota Damansara 47810 Petaling Jaya, Selangor	Internet	www.solartech.com.my
		Testdatum	08.2012

System-Data

No. of collector modules / pipes	1
Gross collector array area	1.977 m ²
Storage tank volume	180 l
Design load	126 l/d

Types of collector mounting

- Construction for sloping roof
- Integration into sloping roof
- On flat roof with stand
- Facade

Annual performance prediction and solar fraction for the EN locations

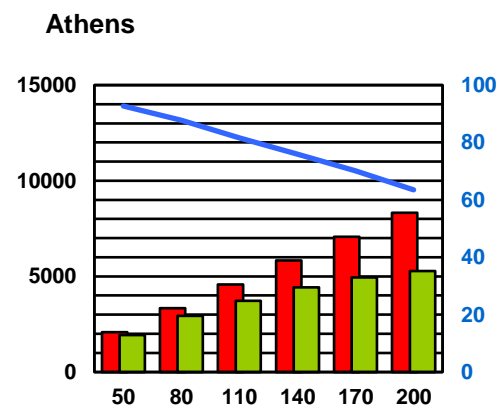
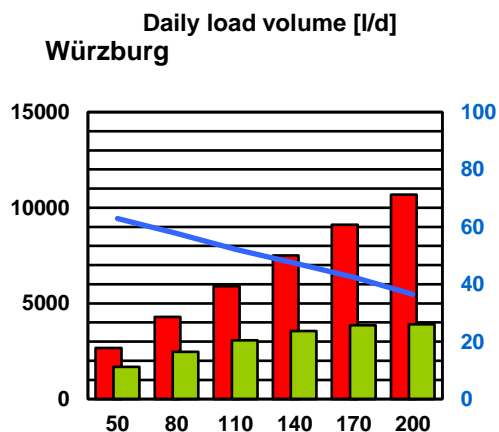
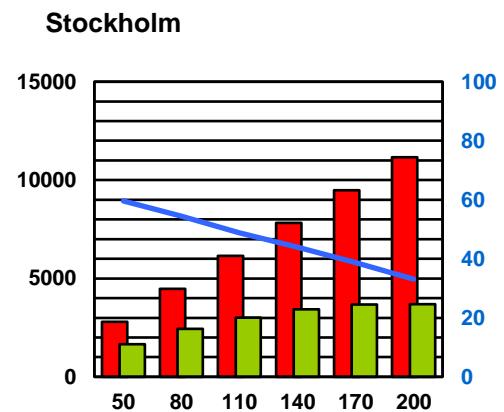
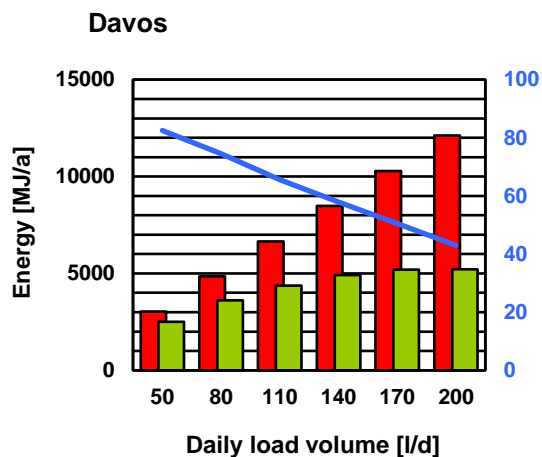

— f_{sol} : Solar fraction % ($f_{sol} = Q_L/Q_d$) ■ Q_L : Heat delivered by the solar system (load) ■ Q_d : Heat demand

¹ Homepage of Solar Keymark, URL: www.solarkeymark.org